

Betty ^{TK11}
Thau & Kallio
2024

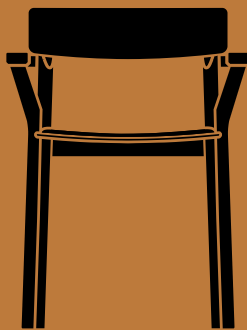

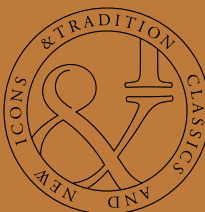
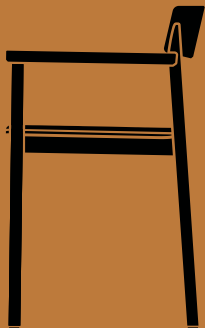
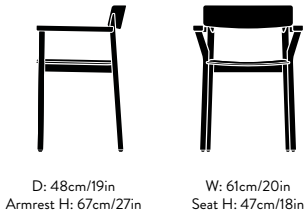

H: 78cm/30in

D: 48cm/19in
Armrest H: 67cm/27in

W: 61cm/20in
Seat H: 47cm/18in

Betty^{TK11}

Thau & Kallio

2024

Product description

Armchair

Environment

Indoor

Material

Lacquered or Oiled solid oak and formpressed veneer with HR foam seat. This product has not been treated with any biocides.

Production process

The chair is made from solid oak and formpressed veneer.

Variants

Clear lacquered oak, Smoked oiled oak, Black lacquered oak. Available in a variety of fabrics, leathers and COM.

Gliders

Wagner QuickClick felt fliders with interchangeable plastic inserts are installed as standard.

Dimensions

H: 78cm / 30in, W: 61cm / 20in, D: 48cm / 19in
Seating D: 42cm / 16.5in, Seating H: 47cm / 18in
Armrest H: 67cm / 27in

Packaging dimensions

H: 90cm / 35in, W: 50cm / 19in,
D: 62.5cm / 24in

Colli quantity

1 (2 pcs)

Stacking quantity

8 pcs

Weight

Product: 6.6 kg
Incl. packaging: 14.5 kg

Country of origin

Latvia

Strength, durability and safety testing

The chair is tested for strength, durability and safety according to EN 16139 Level 2 - Extreme use

Warranty

5 years

Cleaning instructions

Please download our Material Care & Cleaning instructions through www.andtradition.com

→ Stock items

Black lacquered ash w. Black leather
Oak lacquered oak w. Cognac leather
Smoked oak w. Black leather

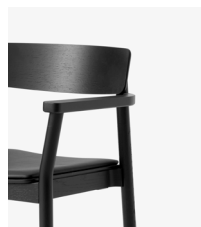

→ Black lacquered ash w. Black leather



→ Oak lacquered oak w. Cognac leather



→ Smoked oiled oak w. Black leather

Related products

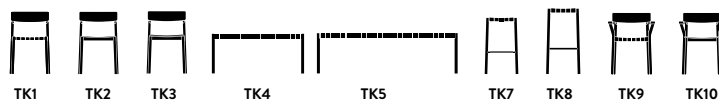

&Tradition[®]



TK11

Recycling & Disassembly

Betty^{TK11}

RECYCLING

The Betty chair is built to last, and we hope that your Betty will serve you for many years. The chair is made from solid wood and wood veneer, and can be easily separated from its base. All metal and wooden parts can be separated and delivered to a suitable recycling station.

SPARE PARTS

To purchase spare parts for your Betty chair, please write to our sales support team at info@andtradition.com with your query.

5 YEAR WARRANTY

&Tradition provides a 5-year warranty with every Betty chair, which covers faults which were present at the time of purchase, or which have occurred as a result of a manufacturing defect. The warranty is valid from the date stated on the original invoice.

DISASSEMBLY

1. Unscrew the bolts located inside the frame of the seat. This can be done with a socket wrench.

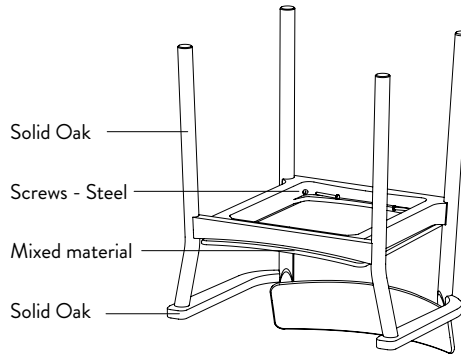

2. Unscrew the bolts underneath the seat, and divide the seat into the individual materials. For proper recycling.

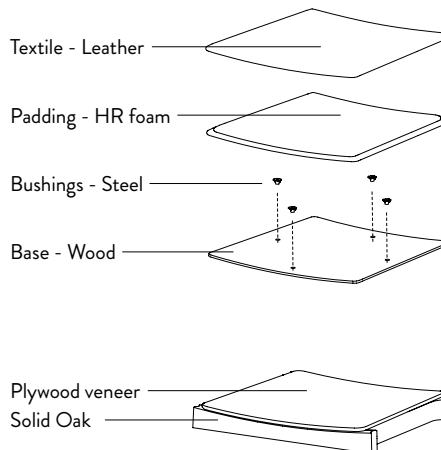

3. Remove the gliders

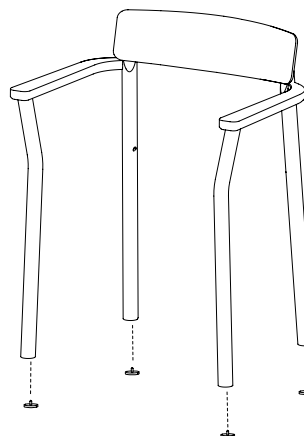

Gliders - PE & felt