

Rely ^{HW6-HW10}
Hee Welling
2020

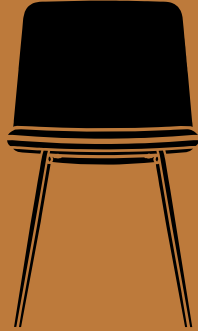

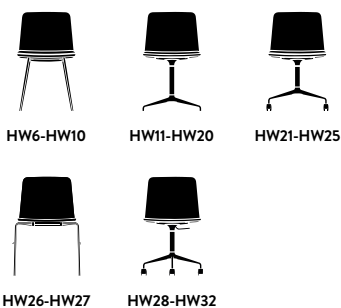

Rely Hee Welling 2020

RECYCLING

The Rely is built to last, and we hope that your Rely will serve you for many years. Its shell is made from 100% recycled material, and can be easily separated from its base. All metal and plastic parts can be separated and delivered to a suitable recycling station.

SPARE PARTS

To purchase spare parts for your Rely chair, please write to our sales support team at info@andtradition.com with your query.

5 YEAR WARRANTY

&Tradition provides a 5-year warranty with every Rely chair, which covers faults which were present at the time of purchase, or which have occurred as a result of a manufacturing defect. The warranty is valid from the date stated on the original invoice.





HW6

Rely^{HW6} Hee Welling 2020

Product category
Chair w. plastic shell

Environment
Indoor

Production process
Shell made from 100% recycled polypropylene with 15% fiber glass. Tube base is made from steel tubes in a powder coated or chrome finish.

Material
Polypropylene, glass fiber, steel tube base.
Seat pad available upon request.
This product has not been treated with any biocides.

Base finishes
Chrome, Bronzed, Black

Shell colours
Black, White, Red Brown, Light Blue, Beige Sand, Stone Grey

Certifications



Strength, durability and safety testing
The chair is tested for strength, durability and safety according to: – EN 16139 Level 2 – Extreme use.

Related products



HW7-HW10 HW11-HW20



HW21-HW25 HW26-HW27



Dimensions

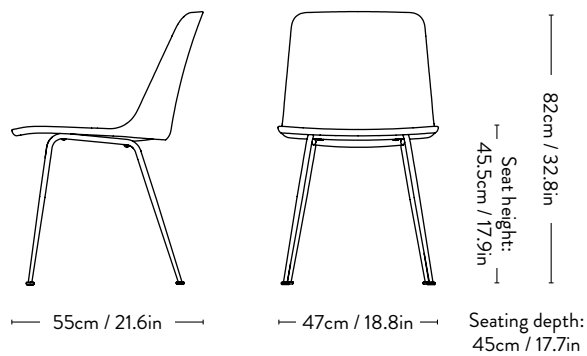



HW6

Rely^{HW6}

Hee Welling

2020

Packaging dimensions

H: 84cm / 33.6in

W: 51cm / 20.4in

D: 60cm / 24in

Weight

Product: 5.2kg / Incl. packaging: 8.3kg

Gliders

Plastic gliders installed as standard. Felt gliders available upon request.

Manufacturer

Produced in Poland by Trio Line Polska Sp. z o.o.

Cleaning Instructions

Please click [here](#) to download our Material Care & Cleaning Instructions.

Base finishes



Chrome



Bronzed



Black

Shell colours



Black



White

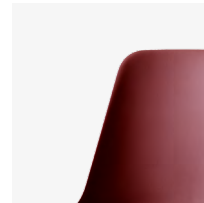

Red Brown



Light Blue

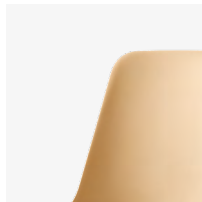

Beige Sand

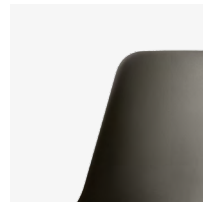

Stone Grey

Seat pad



* COM must be approved by &Tradition to ensure suitability for upholstery.



HW7

Rely^{HW7} Hee Welling 2020

Product category

Chair w. plastic shell & seat cushion

Environment

Indoor

Production process

Shell made from 100% recycled polypropylene with 15% fiber glass. Upholstered seats are made with a veneer plate with 30mm foam. Tube base is made from steel tubes in a powder coated or chrome finish.

Material

Polypropylene, glass fiber, foam, upholstery, steel tube base.

This product has not been treated with any biocides.

Base finishes

Chrome, Bronzed, Black

Shell colours

Black, White, Red Brown, Light Blue, Beige Sand, Stone Grey

Certifications

FSC Mix (C154398): Seat cushion



Strength, durability and safety testing

The chair is tested for strength, durability and safety according to: – EN 16139 Level 2 – Extreme use.

Related products



Dimensions

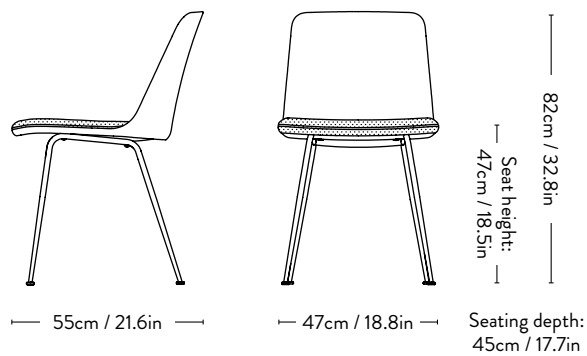



HW7

Rely^{HW7}

Hee Welling

2020

Packaging dimensions

H: 84cm /33.6in

W: 51cm/20.4in

D: 60cm/24in

Weight

Product: 5.2kg / Incl. packaging: 8.3kg

Gliders

Plastic gliders installed as standard. Felt gliders available upon request.

Seat upholstery

Seat upholstery available in all fabrics, leathers and COM.

Fabric usage: 70x70cm (0.49 meter).

Leather usage: 100x100cm (1 square meter).

COM must be approved by &Tradition to ensure suitability for upholstery.

Manufacturer

Produced in Poland by Trio Line Polska Sp. z o.o.

Cleaning Instructions

Please click [here](#) to download our Material Care & Cleaning Instructions.

Base finishes

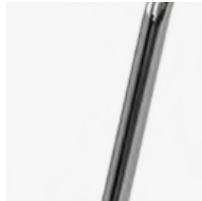

Chrome



Bronzed



Black

Shell colours

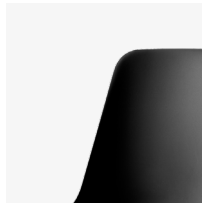

Black



White

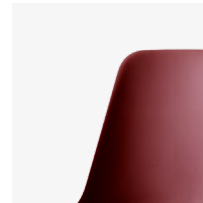

Red Brown

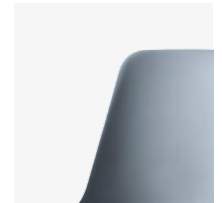

Light Blue

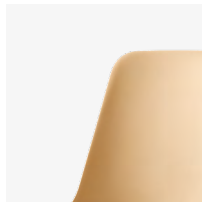

Beige Sand

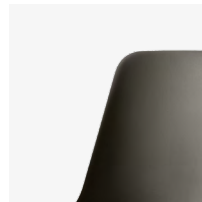

Stone Grey



HW8

Rely^{HW8} Hee Welling 2020

Product category
Upholstered chair

Environment
Indoor

Production process
Shell made from 100% recycled polypropylene with 15% fiber glass. Upholstered seats are made with a veneer plate with 30mm foam. Tube base is made from steel tubes in a powder coated or chrome finish.

Material
Polypropylene, glass fiber, foam, upholstery, steel tube base.
This product has not been treated with any biocides.

Base finishes
Chrome, Bronzed, Black

Certifications



Strength, durability and safety testing
The chair is tested for strength, durability and safety according to: – EN 16139 Level 2 – Extreme use.

Related products



HW6-HW7, HW9-HW10 HW11-HW20



HW21-HW25 HW26-HW27



Dimensions

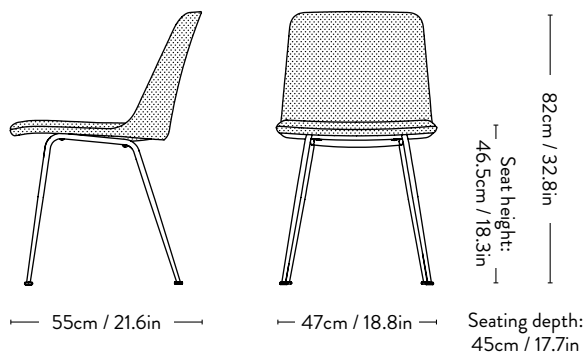



HW8

Rely^{HW8}

Hee Welling

2020

Packaging dimensions

H: 84cm /33.6in

W: 51cm/20.4in

D: 60cm/24in

Weight

Product: 5.7kg/ Incl. packaging: 8.8kg

Gliders

Plastic gliders installed as standard. Felt gliders available upon request.

Upholstery

Shell upholstery available in all fabrics, leathers and COM

Fabric usage: 1.40 meters based on a 140cm roll.

Leather usage: 2.2 square meters.

COM must be approved by &Tradition to ensure suitability for upholstery.

Manufacturer

Produced in Poland by Trio Line Polska Sp. z o.o.

Cleaning Instructions

Please click [here](#) to download our Material Care & Cleaning Instructions.

Base finishes

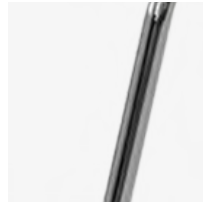

Chrome



Bronzed



Black



HW9 & HW10

Rely^{HW9 & HW10} Hee Welling 2020

Product category

Upholstered chair w. seat cushion

Environment

Indoor

Production process

Shell made from 100% recycled polypropylene with 15% fiber glass. Upholstered seats are made with a veneer plate with 30mm foam. Tube base is made from steel tubes in a powder coated or chrome finish.

Material

Polypropylene, glass fiber, foam, upholstery, steel tube base.

This product has not been treated with any biocides.

Base finishes

Chrome, Bronzed, Black

Certifications

FSC Mix (C154398): Seat cushion



Strength, durability and safety testing

The chair is tested for strength, durability and safety according to: - EN 16139 Level 2 - Extreme use.

Related products



HW6-HW8 HW11-HW20



HW21-HW25 HW26-HW27



Dimensions

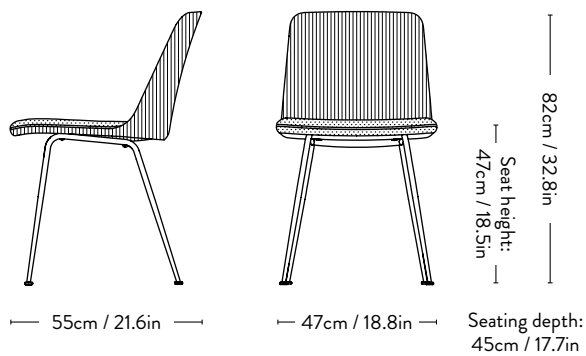



HW9 & HW10

Rely^{HW9 & HW10}

Hee Welling

2020

Packaging dimensions

H: 84cm /33.6in

W: 51cm/20.4in

D: 60cm/24in

Weight

Product: 6.8kg/ Incl. packaging: 9.9kg

Gliders

Plastic gliders installed as standard. Felt gliders available upon request.

Upholstery

HW9: Shell + seat upholstery available in all fabrics, leathers and COM (mono upholstery)

Fabric usage: 1.8 meters based on a 140cm roll.

Leather usage: 2.7 square meters

HW10: Upholstered shell with a mixed seat upholstery available in all fabrics, leathers and COM. Fabric usage: 1.9 meter (Shell: 1.2 meters / Seat: 0.7 meter). Leather usage: 2.9 square meters (Shell: 2 sqm / Seat: 0.9 sqm).

COM must be approved by &Tradition to ensure suitability for upholstery.

Manufacturer

Produced in Poland by Trio Line Polska Sp. z.o.o.

Cleaning Instructions

Please click [here](#) to download our Material Care & Cleaning Instructions.

Base finishes



Chrome



Bronzed



Black